

Article number: 437900050

Description: Rota-fix shaft-hub connection SA 50

Measures

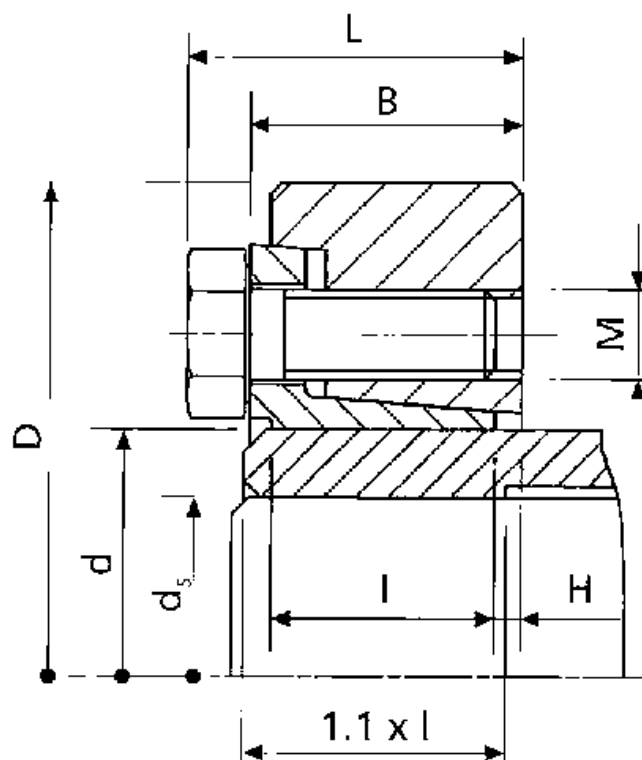

B mm	= 26.0	M mm	= M8
d H8 mm	= 50	T N m torque	= 1150
D mm	= 90.0	Ts N m bolt tightening torque	= 30
ds mm	= 38		
F kN torque	= 61		
H	= 2.5		
I mm	= 22.0		
L mm	= 31.5		